

	S E L E C T	A	←→ Min=13.300mm Max=16.000mm	↕ Min=500mm Max=1.200mm	Min. Thickness: 5mm	Max. 7.000 kg
		B	←→ Min=2.900mm Max=8.100mm	↕ Min=1.200mm Max=3.500mm		Max. 4.600 kg
		C	←→ Min=8.100mm Max=13.300mm	↕ Min=1.200mm Max=3.500mm		Max. 9.300 kg
		D	←→ Min=13.300mm Max=16.000mm	↕ Min=1.200mm Max=3.500mm		Max. 14.000 kg

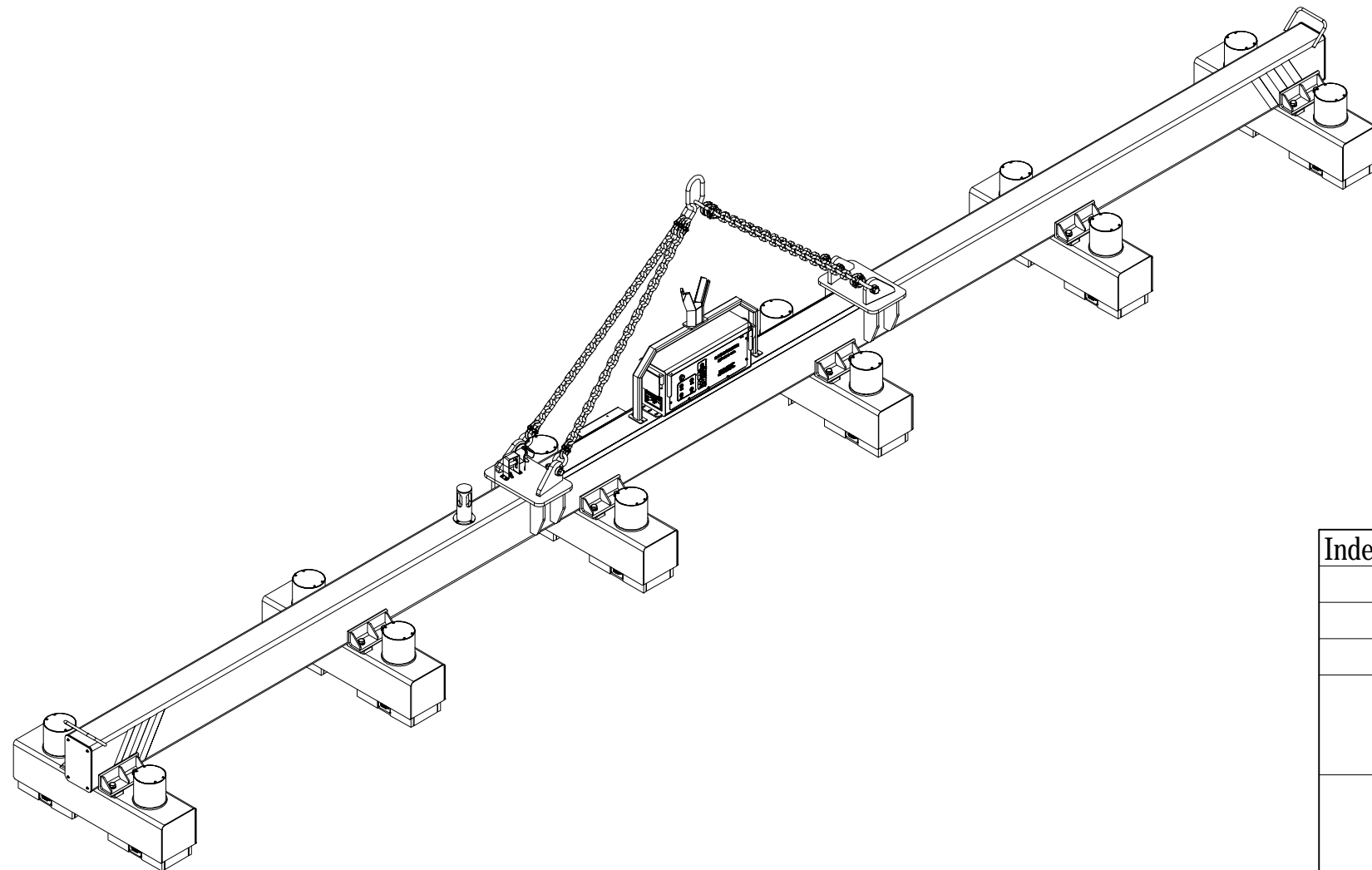
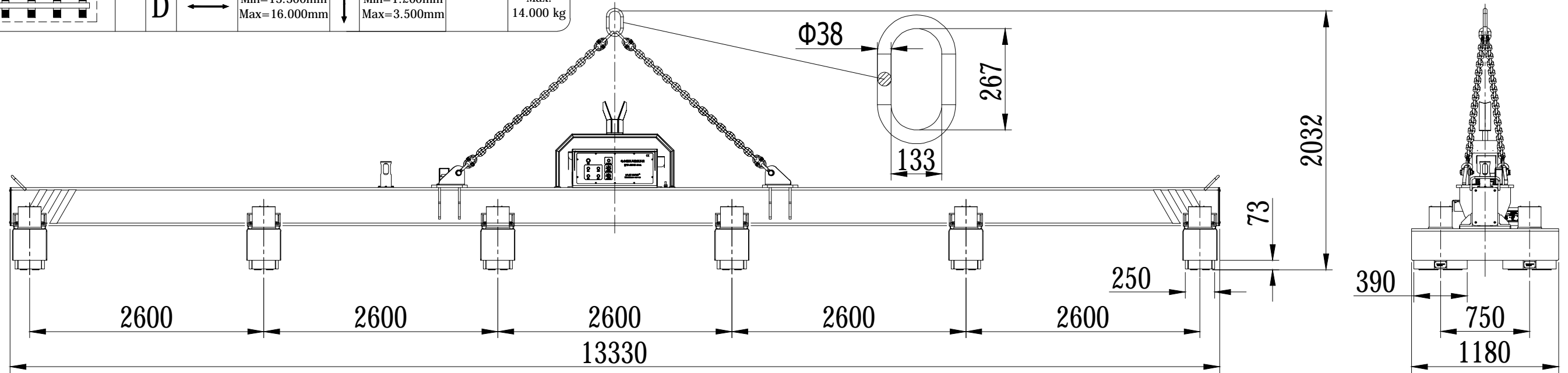

Indicative Weight: 2.700 kg

Indicative drawing. We reserve the right to modify the design at any time

Index	Date	Modification	Name
			Date: 20/08/2020
			Scale: 1:50
HM1-16-140 EPM beam for lifting of steel plate			Checked: BIN
			Unit:mm
			HFA20125.00 Indicative drawing

HVR MAG®