

SELECT	A	←	Min=9.500mm Max=12.000mm	↕	Min=500mm Max=1.200mm	Min. Thickness: 5mm	Max. 2.500 kg
	B	←	Min=9.500mm Max=12.000mm	↕	Min=500mm Max=1.200mm		Max. 2.500 kg
	C	←	Min=5.000mm Max=9.500mm	↕	Min=1.200mm Max=3.200mm		Max. 3.000 kg
	D	←	Min=9.500mm Max=12.000mm	↕	Min=1.200mm Max=3.200mm		Max. 5.000 kg

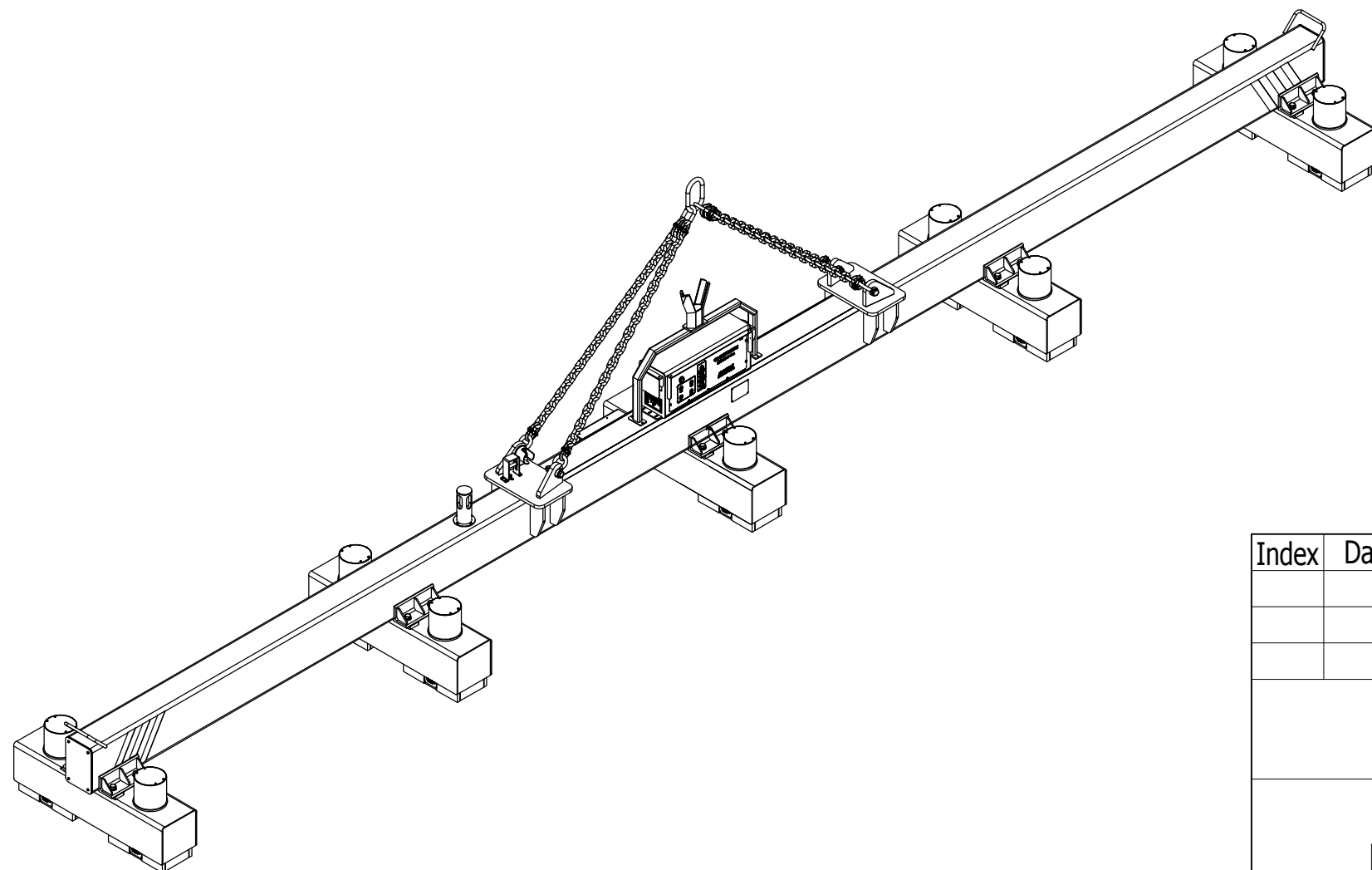
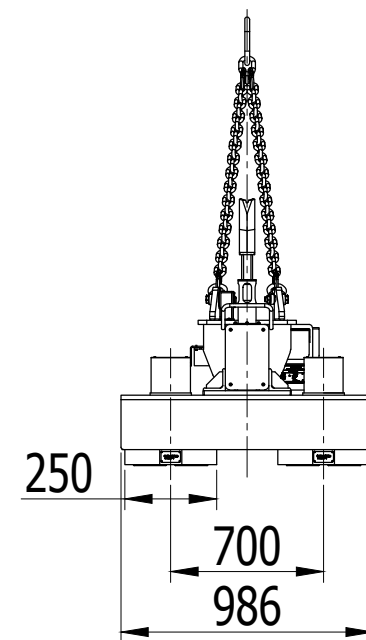
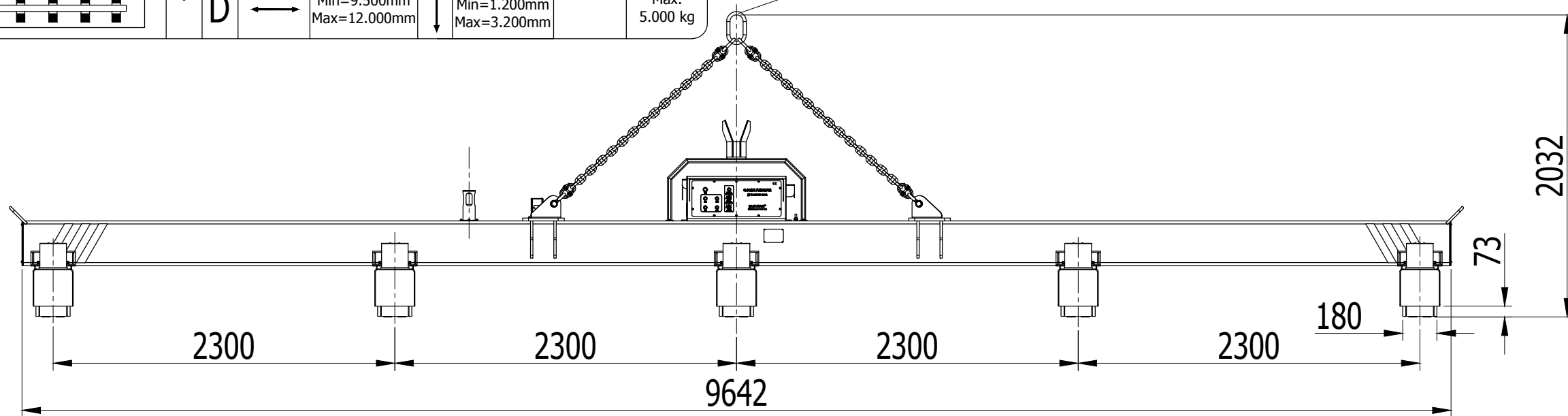
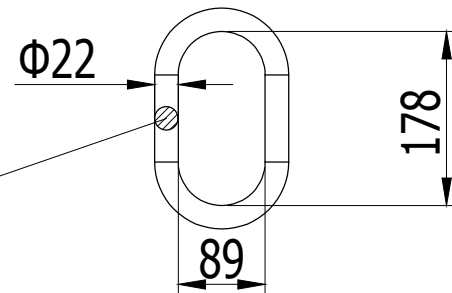

Indicative Weight: 1.600 kg

Indicative drawing. We reserve the right to modify the design at any time

Index	Date	Modification	Name
			<b>HVR MAG®</b>
HM1-12-050 EPM beam for lifting of steel plate			Date: 20/06/2020    Scale: 1:50 Drawing: QI Checked: BIN    Unit:mm
			HFA20118.00 Indicative drawing