

S E L E C T	A	←→	Min=5.200mm Max=8.000mm	↕	Min=500mm Max=1.250mm	Min. Thickness: 5mm	Max. 6.000 kg
	B	←→	Min=2.000mm Max=3.600mm	↕	Min=1.250mm Max=3.200mm		Max. 6.000 kg
	C	←→	Min=3.600mm Max=5.200mm	↕	Min=1.250mm Max=3.200mm		Max. 9.000 kg
	D	←→	Min=5.200mm Max=8.000mm	↕	Min=1.250mm Max=3.200mm		Max. 12.000 kg

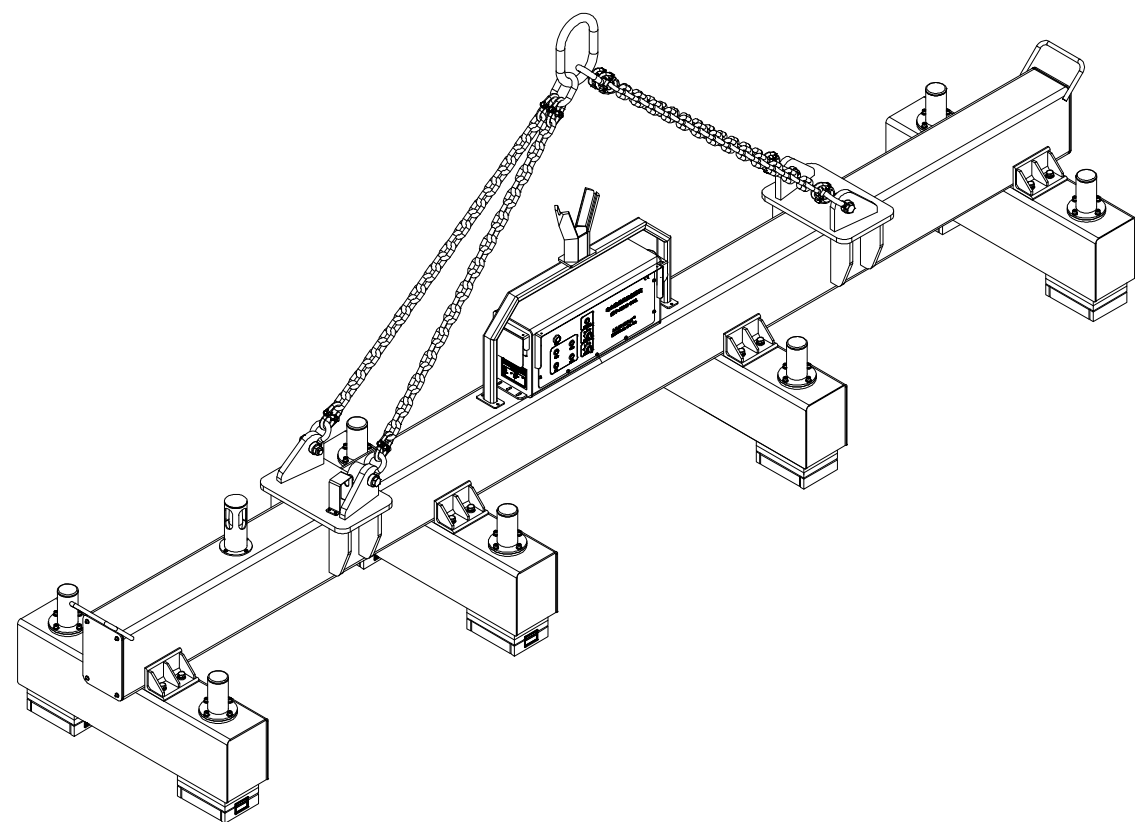
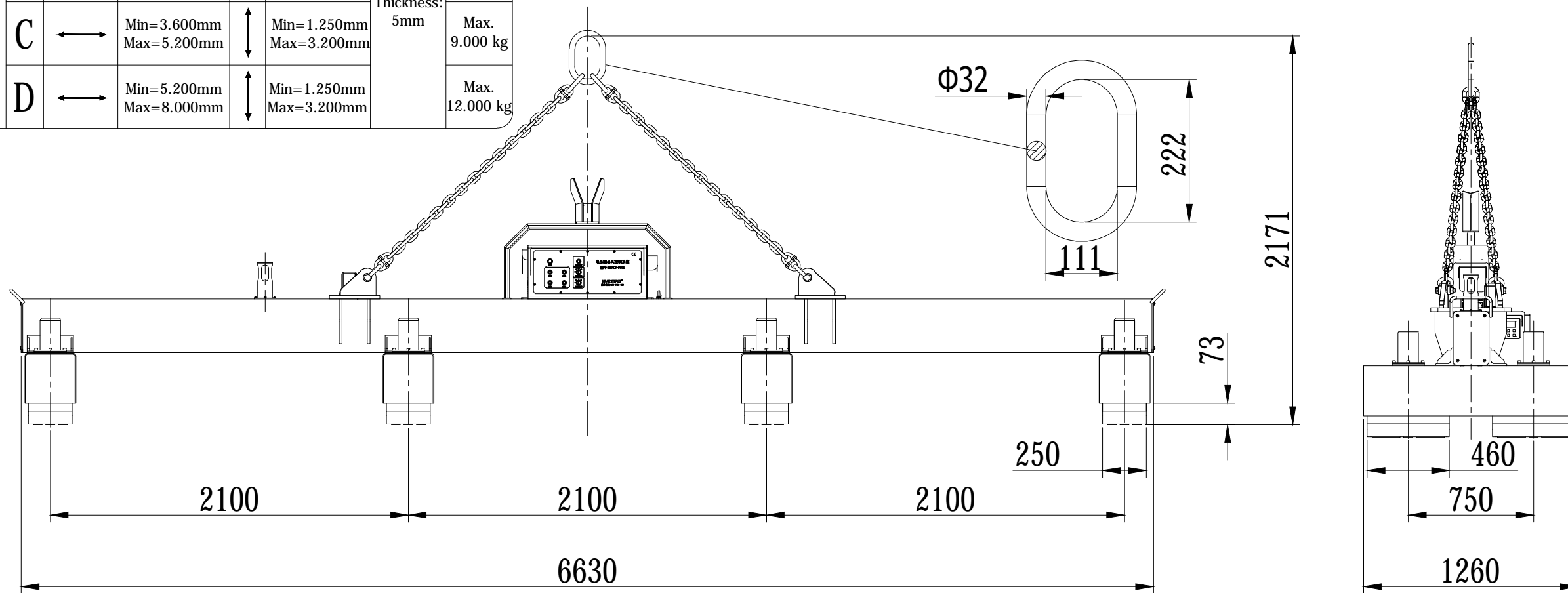

Indicative Weight: 1.500 kg

Indicative drawing. We reserve the right to modify the design at any time

Index	Date	Modification	Name
			Date: 20/08/2020
			Scale: 1:40
HM1-09-120 EPM beam for lifting of steel plate			Checked: BIN
			Unit:mm
			HFA20116.00 Indicative drawing

HVR MAG®