

	S E L E C T	A	↔ Min=3.000mm Max=6.000mm	↕ Min=500mm Max=1.500mm	Min. Thickness: 5mm	Max. 3.000 kg
		B	↔ Min=6.000mm Max=12.000mm	↕ Min=500mm Max=1.500mm		Max. 6.000 kg
		C	↔ Min=3.000mm Max=6.000mm	↕ Min=1.500mm Max=3.000mm		Max. 6.000 kg
		D	↔ Min=6.000mm Max=12.000mm	↕ Min=1.500mm Max=3.000mm		Max. 12.000 kg

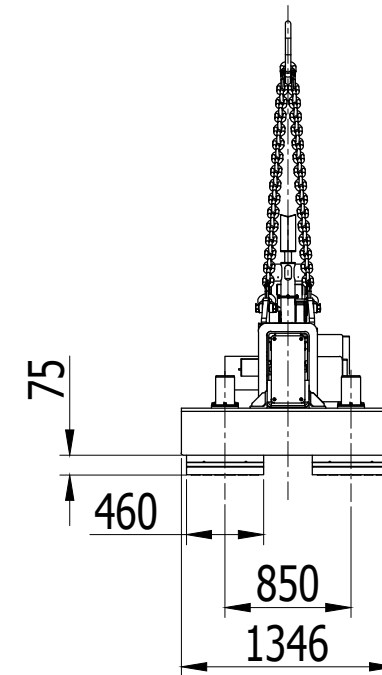
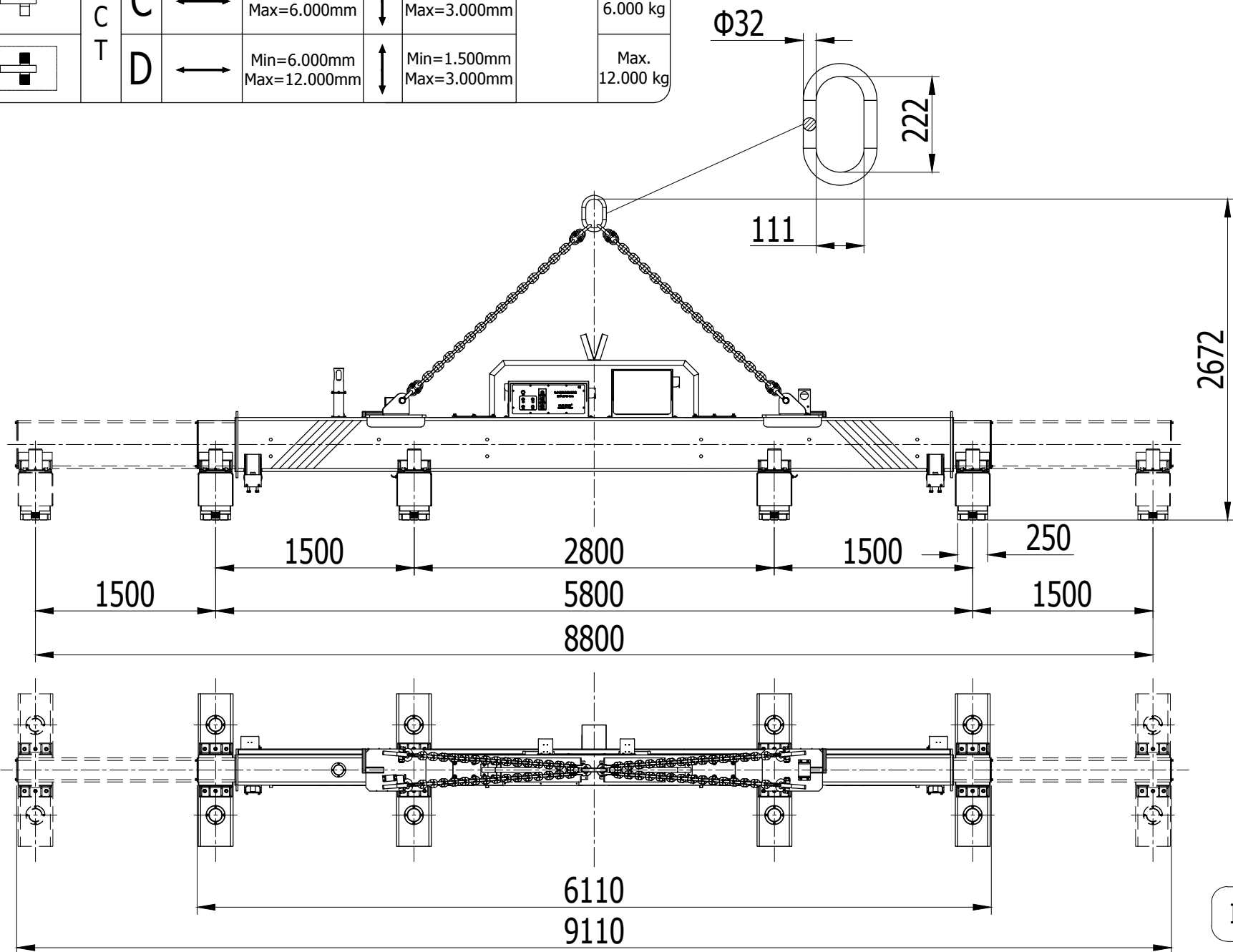

Indicative Weight: 2.800 kg

Indicative drawing. We reserve the right to modify the design at any time

Index	Date	Modification	Name
			Date: 22/06/2020
			Scale: 1:65
HM2-12-120 EPM beam for lifting of steel plate			Checked: BIN
			Unit:mm
			HFA20132.00 Indicative drawing

HVR MAG®